

IR AUTOMATION GUIDEBOOK

Temperature Monitoring and Control with IR Cameras

Content

page

1. Typical monitoring and control applications	4
2. Remote IR monitoring	10
3. Temperature measurement for automated processes	26
4. Combine machine vision and temperature measurement	36

Published by FLIR AB

This booklet may not be reproduced in any form without the permission in writing from FLIR Systems, AB. © Copyright. All rights reserved.



IR Automation Guidebook

Manufacturing and process engineers are under constant pressure to make production systems and processes more efficient and less costly. Frequently, their solutions use automation techniques to improve throughput and product quality. Automated IR (infrared) radiation imaging offers the potential for improving a host of industrial production applications, including process monitoring and control, quality assurance, asset management, and machine condition monitoring.

This handbook is intended to help those considering the creation or improvement of production automation or monitoring systems with IR cameras. Numerous application examples will be presented with explanations of how these IR vision systems can best be implemented.

Some of the major topics that will be covered include:

- Integration of IR cameras into automation systems
- Data communications interfaces
- Command and control of thermographic cameras
- Principles of thermographic measurements
- Interfacing with a PC or PLC controller
- Standard software packages for IR camera systems

These complex matters require attention to many details; therefore, this handbook cannot answer every question a system designer will have about the use of IR cameras in automated systems. It is meant to serve only as a roadmap through the major issues that must be faced in IR vision system design.

1. Typical monitoring and control applications

Temperature measurements with IR cameras

Infrared (IR) radiation is not detectable by the human eye, but an IR camera can convert it into a visual image that depicts thermal variations across an object or scene. IR covers a portion of the electromagnetic spectrum from approximately 900 to 14,000 nanometers (0.9–14 μm). IR is emitted by all objects at temperatures above absolute zero, and the amount of radiation increases with temperature. A properly calibrated IR camera can capture thermographic images of target objects and can provide accurate non-contact temperature measurements of those objects. These quantitative measurements can be used in a variety of monitoring and control applications.

In contrast, other types of IR imagers provide only relative temperature differences across an object or scene. Hence, they are used to make qualitative assessments of the target objects, primarily in monitoring applications where thermal images are interpreted based on temperature contrast. One example is to identify image areas that correlate to physical anomalies, such as construction or sub-surface details, liquid levels, etc.

In some cases, an IR camera is justifiably referred to as a smart sensor. In these cases the IR camera has built-in logic and analytics that allows the comparison of measured temperatures with user-supplied temperature data. It also has a digital I/O interface so that a differential temperature can be used for alarm and control functions. In addition, a smart IR camera is a calibrated thermographic instrument capable of accurate non-contact temperature measurements.

IR cameras with these capabilities operate much like other types of smart temperature sensors. They have fast, high-resolution A/D (Analog to Digital) converters that sample incoming data, pass it through a calibration function, and provide temperature readouts. They may also have other communication interfaces that provide an output stream of analog or digital data. This allows thermographic images and temperature data to be transmitted to remote locations for process monitoring and control.

Generally, smart IR cameras are used in quantitative applications that require accurate measurements of the temperature difference between a target object and its surroundings. Since temperature changes in most processes are relatively slow, the near-real-time data communications of smart IR cameras are adequate for many process control loops and machine vision systems.

Automation applications

Typical automated applications using IR cameras for process temperature monitoring and control include:

- Continuous casting, extrusion, and roll forming
- Discrete parts manufacturing
- Production where contact temperature measurements pose problems
- Inspection and quality control
- Packaging production and operations
- Environmental, machine, and safety monitoring
- Temperature monitoring as a proxy for other variables

The examples below demonstrate a wide range of applications that can be served with IR cameras. Potential applications are limited only by the imagination of the system designer.

Plywood mill machine monitoring

Problem: Steam from open vats of hot water obscures the machinery operator's view of the logs as they are maneuvered for proper alignment in the log vat.

Solution: An IR camera can present an image to the operator that makes the cloud of steam virtually transparent, thereby allowing logs to be properly aligned in the log vat. This example of a qualitative application is illustrated in Figure 1.

Figure 1. Plywood mill application



The problem

- Operators cannot see through the steam cloud caused by condensation in cooler air temperatures.



The solution

- IR offers another pair of "eyes" to see through the steam into the log vat for proper log alignment.

Production testing of car seat heaters

Problem: Using contact temperature sensors to assure proper operation of optional car seat heaters slows down production and is inaccurate if sensors are not properly placed.

Solution: An IR camera can detect thermal radiation from the heater elements inside the seats and provide an accurate non-contact temperature measurement.

This quantitative measurement can be made with a camera that is permanently mounted on a fixture that is swung into measurement position when the car reaches a designated point on the assembly line. A monitor near that position provides an image with a temperature scale that reveals the temperature of the car seat heater elements, as shown in Figure 2.

Figure 2. Production testing of car seat heater elements



The problem

- Optional features in vehicles cannot be inspected without some type of contact.
- This slows down production.
- 100% inspection is tedious.



The solution

- An IR camera can be permanently mounted to inspect these items.
- An IR camera can be used in a non-contact method.

Packaging operations

Problem: On a high-speed packaging line, efficient methods for non-destructive testing of a glued box seal are scarce, and most tend to be very cumbersome. In addition, the glue application method has a good deal of variability that must be monitored and recorded with statistical quality control routines.

Solution: Since the glue is heated prior to application, its temperature and locations on the box lid can be monitored with an IR camera. Moreover, the image can be digitized in a way that allows this information to be stored in a statistical quality control database for trend analysis and equipment monitoring as shown in Figure 3.

This is an example of using differential temperature as a proxy for another variable. In this case, temperature replaces mechanical methods of inspection/testing.

Figure 3. Machine vision box seal quality control



The problem

- Detect incorrectly sealed boxes.
- Remove failed units from the line.
- Generate an alarm if too many boxes fail.
- Log statistical data of pass/fail.



The solution

- Capture a thermal image of the box.
- Detect presence of glue spots.
- Pass/fail on each box.
- Log statistics.

SUMMARY

The automation examples presented in this chapter have barely scratched the surface of the application space that smart IR cameras can serve. In the following chapters, more detailed examples will be presented along with practical information on the implementation of automated systems that exploit the advantages of IR cameras. These chapters are organized according to the major types of applications that typically use IR cameras:

- Remote thermographic monitoring
- Non-contact temperature measurement for automated processes
- Combining IR machine vision with temperature measurement
- Real-time control and monitoring – issues and answers

2

2. Remote IR monitoring

Overview

Infrared radiation is emitted by all objects at temperatures above absolute zero and is detectable by IR cameras. Since these cameras have various means of communicating thermographic images and temperatures to remote locations, they are ideal for remote and unattended monitoring. Moreover, smart IR cameras (those with built-in logic, analytics, and data communications), can compare the temperatures obtained from their thermographic images with user-defined settings. This allows the camera to output a digital signal for alarm and control purposes, while also providing live images.

IR camera operation

IR camera construction is similar to a digital video camera. The main components are a lens that focuses IR onto a detector, plus electronics and software for processing and displaying thermographic images and temperatures on an LCD or CRT monitor (Figure 1). Instead of a charge coupled device that video and digital still cameras use, the IR camera detector is a focal plane array (FPA) of micrometer size pixels made of various materials sensitive to IR wavelengths. FPA resolution ranges from about 80×80 pixels up to 1024×1024 pixels. In some IR cameras, the video processing electronics include the logic and analytical functions mentioned earlier. Camera firmware allows the user to focus on a specific area of the FPA or use the entire detector area for calculating minimum, maximum, and average temperatures. Typically, temperature measurement precision is $\pm 2^\circ\text{C}$ or better.

The camera lens and distance to the target object results in a field of view (FOV) that determines the spot size covered by each pixel. The pixel's analog output represents the intensity of heat energy received from the spot it covers on the target object. The thermographic image seen on the monitor screen is the result of a microprocessor mapping

Figure 1. Simplified block diagram of an IR camera

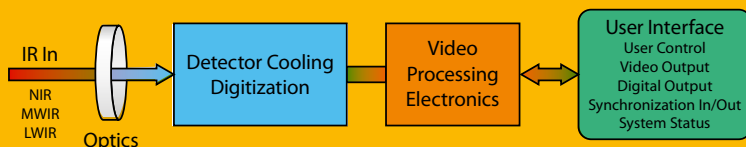

these pixel output values to a color or gray scale scheme representing relative temperatures. In addition, radiometric information associated with the heat energy impinging on a pixel is stored for use in calculating the precise temperature of the spot covered by that pixel.

Hence, IR cameras with these capabilities operate much like other types of smart temperature sensors. Their calibrated outputs can be accessed via one or more communication interfaces and monitored at a remote location. Images saved from these cameras are fully radiometric¹ and can be analyzed off-line with standard software packages, such as those available from FLIR.

Important criteria in remote monitoring systems

When considering an IR camera for a remote monitoring system, some of the important variables to consider are:

- Spot size – the smallest feature in a scene that can be measured
- FOV (Field of View) – the area that the camera sees
- Working distance – distance from the front of the camera lens to the nearest target object
- Real-time control and monitoring – issues and answers
- Depth of field – the maximum depth of a scene that stays in focus
- Resolution – the number of pixels and size of the sensor's active area
- NETD (Noise Equivalent Temperature Difference) – the lowest level of heat energy that can be measured
- Spectral sensitivity – portion of the IR spectrum that the camera is sensitive to
- Temperature measurement range, precision, and repeatability – a function of overall camera design

¹ Radiometry is a measure of how much energy is radiating from an object, as opposed to thermography, which is a measure of how hot an object is; the two are related but not the same.

Another fundamental consideration is which portion of a camera's FOV contains the critical information required for monitoring purposes. The objects within the FOV must provide an accurate indication of the situation being monitored, based on the temperature of those objects. Depending on the situation, the target objects may need to be in the same position consistently within the camera's FOV. Other application variables related to the monitored scene include:

- Emissivity of the target objects
- Reflected temperatures within the FOV
- Atmospheric temperature and humidity

These topics will be covered in more detail in a subsequent chapter.

Remote Asset Monitoring

One type of application where IR cameras are very useful is in remote monitoring of property, inventory, and other assets to help prevent loss and improve safety. Frequently, this involves storage facilities, such as warehouses or open areas for bulk materials. The following example can serve as a general model for setting up an IR camera monitoring system for this type of application.

Hazardous Waste Storage Monitoring. In this application barrels of chemical waste products are stored in a covered facility, but one in which they cannot be totally protected from moisture. Thus, there is the possibility of leaks or barrel contents becoming contaminated by air and moisture, causing a rise in temperature due to a chemical reaction. Ultimately, there is a risk of fire, or even an explosion.

While visible light cameras might be used in such an application, there often is a line-of-sight problem where many of the barrels cannot be seen, even with multiple cameras positioned throughout the storage area. In addition, smoke or flames would have to be present before a visible light camera could detect a problem. This might be too late for preventative measures to be taken. In contrast, stand-alone IR cameras monitoring the facility can detect a temperature rise within their FOV before fire occurs (Figures 2a and 2b).

Figure 2a. IR image of a hazardous waste storage area showing two spot temperature readings [-3.1°C and -8.4°C] that are in the safe range, plus one reading (37.1°C) that is abnormally high.

Figure 2b. A subsequent image of the same area shows that the abnormal reading in 2a has increased further, causing an alarm to go off.

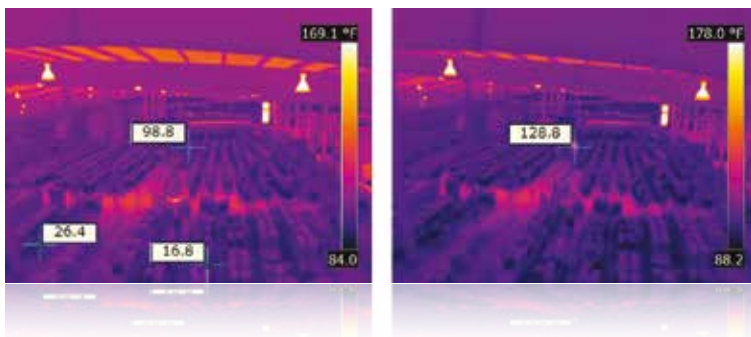

Depending on the camera manufacturer, several monitoring options are available. For instance, the FLIR A320 camera allows a threshold temperature value to be set internally for alarm purposes. In addition, the camera's logic and clock functions can be configured so that a rise in temperature must be maintained for a certain period of time before an alarm is sent. This allows the system to ignore a temporary temperature rise in a camera's FOV caused by a forklift entering the area to add or remove barrels. Furthermore, a hysteresis function can also be used to prevent an alarm from turning off until the detected temperature falls well below the setpoint (Figure 3).

Figure 3. Hysteresis is an important signal processing characteristic of smart IR cameras, which makes monitoring and control functions much more effective.

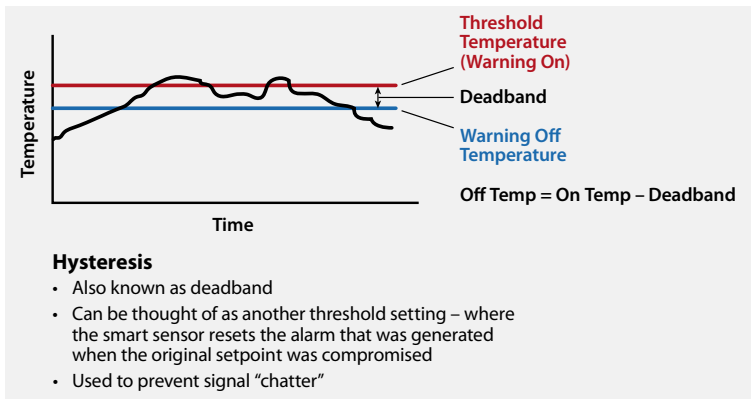

Cameras with a digital interface typically provide an OFF/ON type of output for alarm purposes. The digital output is either off or on; when on, it is typically a DC voltage or current. For example, the digital output from a FLIR A320 camera is 10–30VDC for loads of 100 mA or less. Typically, the digital output is sent to a PLC (Programmable Logic Controller) that controls the portion of an alarm system associated with the monitored area.

A good way to set up the alarm system is to have all cameras configured so they have a high level digital output when the temperature is below the alarm condition that holds a PLC in its non-alarm state. When the alarm setpoint temperature is detected, the camera's digital output goes low (typically zero volts) after an appropriate time delay, causing the PLC to go into its alarm state. This creates a fail-safe system. If power to the camera is lost, then there

is no high level output to the PLC, which treats that event just as if a temperature had reached the setpoint, thereby causing an alarm. This alerts personnel that they have either lost the monitoring function or there is indeed a temperature rise.

Image monitoring. Receiving a warning based on temperature measurements is very useful, but the real power of IR-based asset monitoring is in the camera's image processing capabilities. Control room personnel can get live images from IR cameras that visible light cameras and other temperature detectors cannot provide. Again, cameras vary by manufacturer, but the most versatile ones offer a variety of data communication formats for sending thermographic images to remote locations. Increasingly, web-enabled cameras are used to allow monitoring from any location where a PC is available.

Figure 4 illustrates a system using the FLIR A20's Ethernet and TCP/IP communication protocols in conjunction with its alarm setpoint capabilities. The Ethernet portion of the system allows cable runs of up to 100 meters in length. By communicating a digital alarm directly to the PLC, it can immediately activate a visual and/or audible alarm. The visual alarm can appear on an annunciator panel telling the operator where the alarm originated; the operator then goes to the PC to look at live image(s) of that location. Images and temperature data can be stored for future reference and analysis.

Figure 4. An example of one type of system configuration for remote IR camera monitoring. The system uses a digital alarm output for annunciating an over-temperature condition and transmits streaming MPEG-4 compressed video that allows the scene to be viewed on a PC monitor.

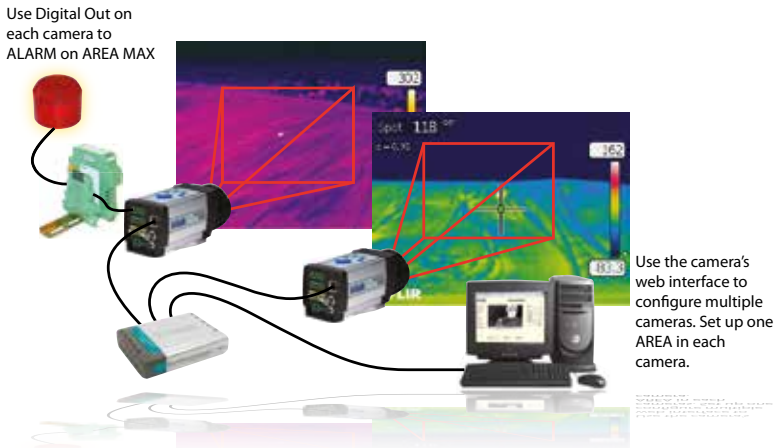

A320 cameras can also be configured to automatically send temperature data and images to a PC via e-mail (SMTP) or ftp protocol whenever the temperature setpoint is reached, thereby creating a record for subsequent review.

In conjunction with a host controller running FLIR's IR Monitor (or other suitable software), temperature data can be captured for trend analysis. The A320 can also supply a digital compression of the camera's analog video signal, which can be sent as MPEG-4 streaming digital video over an Ethernet link to a PC monitor. IR Monitor can be used to set up temperature measurements, image capture, and camera display functions. This application allows the PC to display up to nine camera images at a time and switch between additional camera groups as needed. The FLIR IP CONFIG software can be used to set up each camera's IP address.

After the cameras are configured, the PC used for monitoring does not need to remain on the network continually. By using the ftp and SMTP protocols within the camera, the user can receive radiometric images upon alarm events or on a time based schedule. Also, any available PC with a web browser can be used to access the cameras web server for live video and basic control. This web interface is password protected.

Most IR cameras have an analog video output in a PAL or NTSC format. Therefore, another image monitoring possibility is to use a TV monitor to display thermographic video. A single control room monitor can be used with a switch to view live images from each camera sequentially. When the cameras are properly configured, control room personnel can view scaled temperature readings for any point or area (minimum, maximum, and average) in that image. (See color scales in the screen capture images depicted in Figure 2.) Not only will the operator know when there is excessive heat, he or she can see where it is.

Another example of the innovative functions available in camera firmware or external software is a feature called image masking. This enables the user to pre-select specific areas of interest for analysis of temperature data. This is illustrated in Figure 5, which shows continuous monitoring of substation hotspots that indicate problem areas.

Figure 5. Masking functionality of the FLIR A320 IR camera, which is also available in some third party software programs.

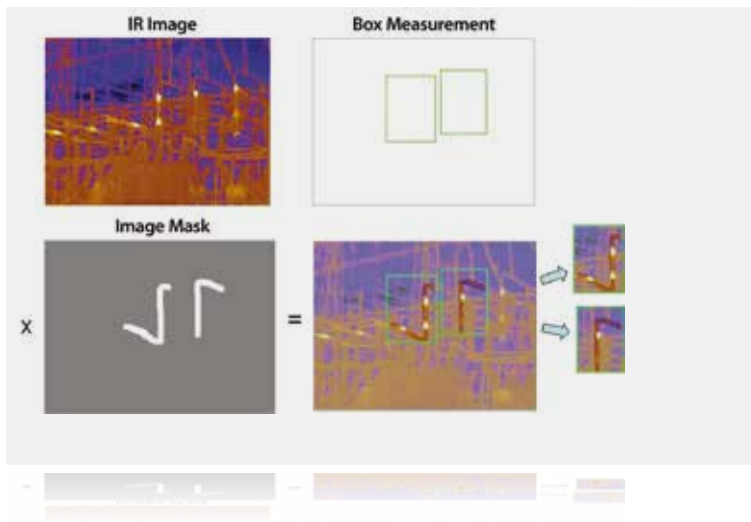

A similar type of pattern recognition software can be used for automated inspection in metal soldering, welding and in laser welding of plastic parts. IR cameras can see heat conducting through the finished parts to check the temperature of the areas where parts are joined together against a stored value. In addition, the software can learn a weld path to make sure this path is correct, which is accomplished by programming the specific pixels in an image to be used by the software for this purpose. Alternatively, the program developer can save an image of a “perfect” part and then have the software look for minimum, maximum, or delta values that tells the equipment operator if a part passes inspection. The car seat heater inspection described in Chapter 1 can be an example of this, and the same principle is used in the inspection of car window heater elements by applying power to them and looking at their thermographic image.

Power over Ethernet (PoE). It should be noted that a camera with Ethernet connectivity can be powered from a variety of sources, depending on its design. Typically, a connection for an external DC supply is used, or where available, the camera is powered via PoE (Power over Ethernet). PoE uses a power supply connected to the network with spare signal leads not otherwise used in 10/100baseT Ethernet systems. Various PoE configurations are possible. Figure 6 depicts one in which the power source is located at one end of the network. (Gigabit Ethernet uses all available data pairs, so PoE is not possible with these systems.)

Figure 6. Schematic depicting spare-pair PoE delivery using the endpoint PSE arrangement.

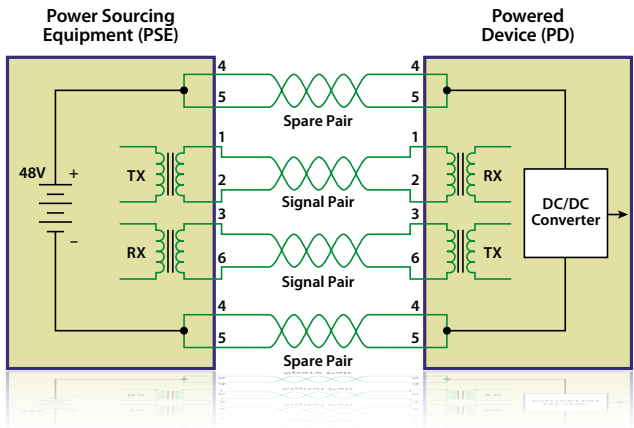

PoE eliminates the need for a separate power source and conduit run for each camera on the network. The only additional cost is for some minor electrical hardware associated with PoE.

Many applications encompass areas that exceed the maximum Ethernet cable run of 100 m. In those cases, there are wireless and fiberoptic converter options that provide off-the-shelf solutions for communicating over much greater distances. These are frequently used in the bulk material storage applications described below.



P/N 196724

320

Additional Asset Monitoring Situations

Bulk Material Storage. Many bulk materials are stored in open yards where air and moisture can help promote decomposition and other exothermic reactions that raise the temperature of the pile. This brings with it the threat of fire, direct monetary loss, and safety issues for personnel. In addition, there is the risk of consequential damages caused by fires, including loss of nearby property, water damage resulting from fire-fighting, and production shutdowns. Materials that are especially prone to spontaneous combustion include organic wastes (compost, etc.), scrap paper for recycling, wood, coal, and various inorganic chemicals, such as cement and chlorine hydrates. Even in the absence of spontaneous combustion, many bulk materials like plastics pose a fire hazard due to sparks or other external ignition sources.

In most cases, prevention is less costly than a cure, and the best prevention is continuous monitoring of the materials. The cost of an automated temperature monitoring system using IR cameras is a modest and worthwhile investment. System design can take the same form as the the one described earlier for hazardous waste barrels. Cameras are configured to generate a direct alarm output to an operator when user-defined maximum temperature thresholds are exceeded. Audible and visual alarms in a control room draw the operator's attention to a possible spontaneous fire development. Various types of software have been developed to isolate trouble spots, such as the waste pile zone monitoring system depicted in Figure 7.

Figure 7. Control room for waste pile processing, and screen capture of the zone monitoring layout, which uses a FLIR IR camera on a pan-tilt mount for fire hazard warning.



Figure 8. Visible light and IR images of a coal pile – the thermographic image clearly identifies a hot spot that is a fire about to erupt.

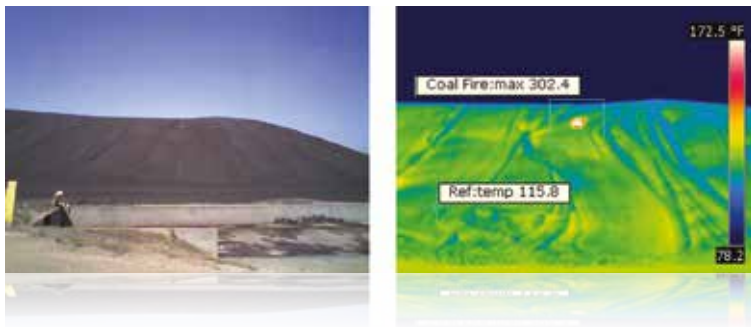

Although self-ignition usually starts within the bottom layers of a stock pile, continuous monitoring of the surface reveals hot spots at an early stage (Figure 8), so measures can be taken to prevent a major fire from breaking out. Large storage yards generally require multiple cameras for total coverage, with the cameras mounted on metal masts above the stock piles. This calls for cameras with housings and other features designed for reliable operation in harsh industrial environments.

Critical Vessel Monitoring (CVM). There are several applications where the temperature of a vessel and its contents are critical. The vessels could be used for chemical reactions, liquid heating, or merely storage. For large vessels, the use of contact temperature sensors poses problems. One reason could be non-uniform temperatures throughout a vessel and across its surface. This would require a large number of contact type sensors, whose installations can become quite costly.

For most CVM applications, a few IR cameras can image nearly 100% of a vessels surface (Figure 9). Moreover, they can measure the surface temperature of the CVM to trend and predict when the internal refractory will break down and compromise the mechanical integrity of the system. If specific regions of interest (ROIs) must be focused on, IR camera firmware (or external PC software) allows the selection of spot temperature points or areas for measurement.

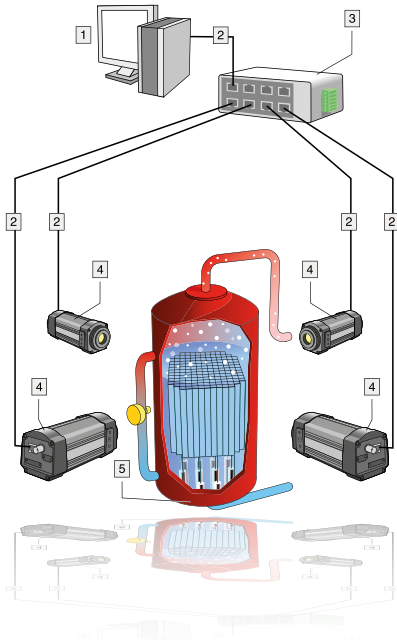

Figure 9. CVM monitoring example showing camera locations, network connections, and PC.

- 1 Computer
- 2 CAT-6 Ethernet cable with RJ45 connectors
- 3 Industrial Ethernet switch with PoE
- 4 FLIR A320 cameras
- 5 Industrial process to be monitored, e.g., a gasifier

Again, some variation of the systems described earlier can be used. Depending on the application environment, an explosion proof housing for the camera may be a requirement. Human-Machine Interface (HMI) software can be used to provide a monitoring overview. These have the ability to combine all of the camera images into a single spatial representation of the monitored area – in this case, a flattened-out view of the vessel. This view can be updated continuously for a near-real-time thermographic representation.

Electrical Substation Monitoring. Reliable operation of substations is crucial for uninterrupted electrical service. Besides lightning strikes and large overloads, aging equipment and connections are a major cause of infrastructure failures and service interruptions. Many of these failures can be avoided with effective preventative maintenance monitoring. Often, the temperatures of transformers, breakers, connections, etc. will begin to creep up before a catastrophic failure occurs. Detection of these temperature increases with IR cameras allows preventative maintenance operations before an unplanned outage happens. (See Figure 10.)

Figure 10. Visible light and IR images of a substation showing a transformer with excessive temperature.



The cameras can be installed on a pan/tilt mounting mechanism to continually survey large areas of a substation. A few cameras can provide real-time coverage of all the critical equipment that should be monitored. In addition to preventative maintenance functions, these cameras also serve as security monitors for intrusion detection around the clock.

By combining the cameras' Ethernet and/or wireless connectivity with a web-enabled operator interface, live images can be transmitted to utility control rooms miles away. In addition, trending software can be used to detect dangerous temperature excursions and notify maintenance personnel via email and snapshot images of the affected equipment.

These features and functions are already in place at leading utility companies in the U.S., such as Exel Energy's "Substation of the Future." Companies such as Exel consider IR monitoring a strategic investment in automation, which is part of a common SCADA (Supervisory Control And Data Acquisition) platform for maintenance and security operations. The most advanced systems provide time-stamped 3-D thermal modeling of critical equipment and areas, plus temperature trending and analysis. A company-wide system of alerts provides alarms on high, low, differential, and ambient temperatures within or between zones in real time.

The previous examples represent just a few applications that can benefit from remote IR camera monitoring. A few other applications where IR temperature monitoring is being used include:

- Oil and gas industries (exploration rigs, refineries, flare gas flues, natural gas processing, pipelines, and storage facilities)
- Electric utilities (power generation plants, distribution lines, substations, and transformers)
- Predictive and preventative maintenance (continuous/fixed position monitoring of critical equipment)

Besides these, there are many qualitative remote monitoring applications where imaging is the predominant feature. For example, IR cameras can be used as part of an early warning system for forest fires, (figure 11) detecting blazes before significant amounts of smoke appear. Another example is using IR imaging to look through condensation vapor that would otherwise obscure an operator's view of equipment and processes. This is being used in coking plants, veneer mills, and plywood log handling operations, among others (see Chapter 1, Figure 1).

Figure 11. Ngaro's IRIS® Watchman forest fire early warning system uses a FLIR IR camera.



SUMMARY

As noted in the text, IR camera temperature data may be used for qualitative monitoring or for quantitative temperature measurement and control. In the former, thermal images are obtained and interpreted based on temperature contrast. It can be used to identify image areas that correlate to sub-surface details, liquid levels, refractory, etc.

Quantitative measurements generally require the IR camera to accurately determine the temperature difference between the target object and its surroundings. In remote monitoring, this allows the temperature data to be used for alarm purposes or to even shut down equipment. Since temperature changes slowly in many situations, the near-real-time data communications of smart IR cameras are more than adequate for alarm and control systems.

3

3. Temperature measurement for automated processes

Background

In Chapter 2 the emphasis was on specific applications where a single temperature threshold is programmed into an IR camera, and when the threshold is reached an alarm is triggered through a PLC. Multiple cameras are often required, but viewing an IR cameras' thermographic image is a secondary consideration – to verify an alarm condition. Chapter 3 focuses on applications where multiple temperatures within a single camera's FOV are important, and that information is used for some sort of process control function. In these applications, the camera is typically integrated with other process control elements, such as a PC or PLC using third party software and more sophisticated communication schemes.

Typical camera measurement functions

Many IR cameras provide the user with different operating modes that support correct temperature measurements under various application conditions. Typical measurement functions include:

- Spotmeter
- Area
- Image mask
- Delta T
- Isotherm
- Temperature range
- Color or gray scale settings

The last two functions are used with the others to provide a visual indication of the range of temperatures in the camera's FOV. Generally, spot and area temperatures tend to be the most useful in monitoring and control applications, and most cameras allow multiple spots or areas to be set within the thermographic image. For example, the FLIR A320 camera supports up to four spots and four areas.

Cursor functions allow easy selection of an area of interest, such as the crosshairs of the spot readings in Figure 1. In addition, the cursor may be able to select circular, square, and irregularly shaped polygon areas.

The spotmeter finds the temperature at a particular point. The area function isolates a selected area of an object or scene and may provide the maximum, minimum, and average temperatures inside that area. The temperature measurement range typically is selectable by the user. This is a valuable feature when a scene has a temperature range narrower than a camera's full-scale range. Setting a narrower range allows better resolution of the images and higher accuracy in the measured temperatures. Therefore, images will better illustrate smaller temperature differences. On the other hand, a broader scale and/or higher maximum temperature range may be needed to prevent saturation of the portion of the image at the highest temperature.

As an adjunct to the temperature range selection, most cameras allow a user to set up a color scale or gray scale to optimize the camera image. Figure 2 illustrates two gray scale possibilities.

In Figure 1, a so-called "iron scale" was used for a color rendering. In a manner similar to the gray scale above, the hottest temperatures can be rendered as either lighter colors or darker colors. Another possibility is rendering images with what is known as a rainbow scale (Figure 3).

Figure 1. IR image of a printed circuit board indicating three spot temperature readings. Image colors correspond to the temperature scale on the right.

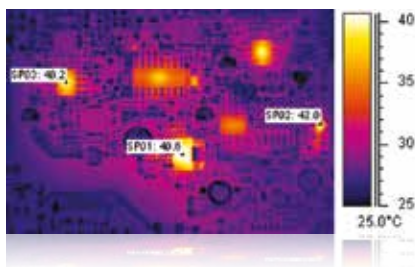

Figure 2. Gray scale images of a car engine – the left view has white as the hottest temperature and the right view shows black as the hottest.

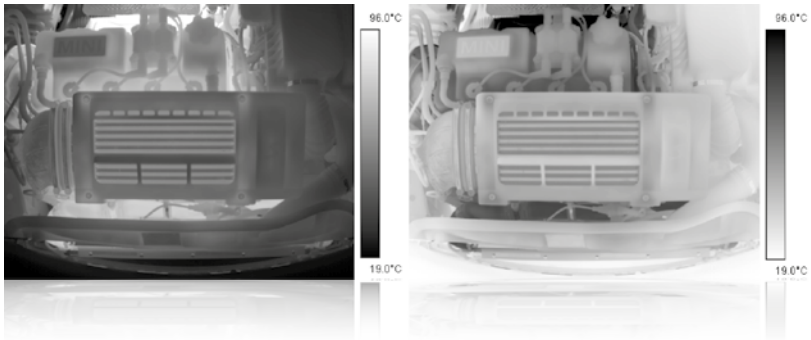
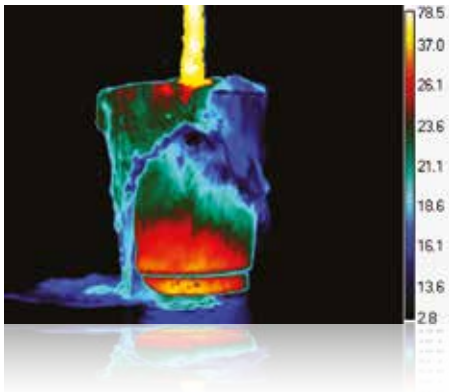

Figure 3. Rainbow scale showing lower temperatures towards the blue end of the spectrum.



Application Examples

Go/No-Go. In these applications, one or more temperatures are monitored to make sure they meet process criteria, and machinery is shut down or product rejected when a measured temperature goes above or below the setpoint. A good example of this is a manufacturer of automotive door panels that uses IR cameras to monitor and measure part temperatures prior to a molding procedure.

This process starts with reinforcing parts that have been stored in a warehouse. In either the warehouse or during transport to the molding line, these parts can become wet due to moisture condensation or exposure to inclement weather. If that happens, they may not reach a high enough temperature in the molding press and finished panels will be of poor quality.

The parts go into the press two at a time from a conveyor where they are sealed together and the finished door panel is molded into the required shape for a specific car model. If the parts are wet, this creates steam in the press and causes mold temperature to be too low. However, it was found that movement of wet parts on the conveyor causes their temperature to be lower than normal.

So, just before the parts go into the press, the conveyor stops and an IR camera makes a non-contact measurement of their temperature. The diagram in Figure 4 is typical for this type of quality control application.

Figure 4. Typical Go/No-Go inspection system using IR cameras.

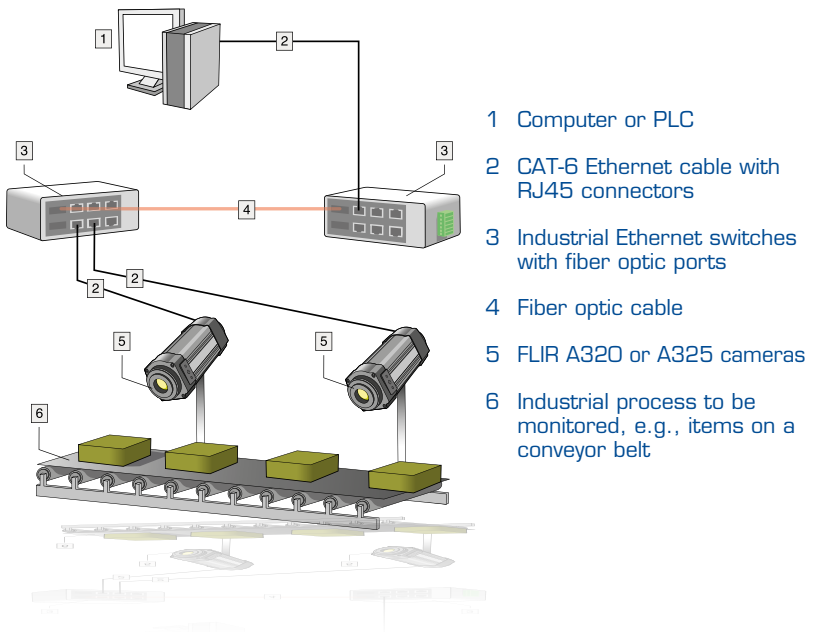

The IR camera's area tools are applied to the thermographic image to check for the minimum allowable temperature of the two parts. If either temperature is below the setpoint (typically, the ambient temperature), then a digital output to a PLC causes an alarm to be sounded and the molding line is halted so the parts can be removed.

For manufacturers preventing bad panels from getting to the end product avoids a potential loss of business. Warranty replacement of a door panel after an end customer takes possession of the car is an expensive proposition for the manufacturer.

The trick is to make sure the camera is measuring the temperature of the parts and not the floor beneath the conveyor, which is within the camera's FOV and typically much cooler. This occurs when the parts are not in the proper position. A photoelectric detector tells the PLC when the parts enter the press area; otherwise its ladder logic ignores the alarm output from the camera.

Continuous Process Monitoring. Temperature is an important variable in many processes. It can either be an integral part of a process or act as a proxy for something else. The following describes an example that encompasses both of these situations.

Artificial fiber production typically involves a continuous extrusion process. Multiple strands may be extruded simultaneously or, in the case of non-woven sheets, a web process may be involved. In either case, monitoring the temperature of the material as it comes out of the extruder can detect strand breakage or material blockage and backup in the process. Using an IR camera for unattended monitoring can catch these malfunctions early, before a huge mess is created that causes a long machinery outage and costly production losses. In addition, the actual temperature readings can be used for trend analysis.

Depending on the application, either the spot or area measurement functions of the camera can be used. In the latter case, it is likely that the application would take advantage of all the area measurement capabilities – minimum, maximum, and average temperatures of the defined area. If any of these were to fall outside the user-defined limits, the application program running on a PC or PLC could instantly shut down the process machinery.

Figure 5 shows a monitored area covering six fiber strands coming out of the extruder, along with an alarm setpoint temperature in the upper left corner.

Figure 5. Monitoring of artificial fibers coming out of an extruder.

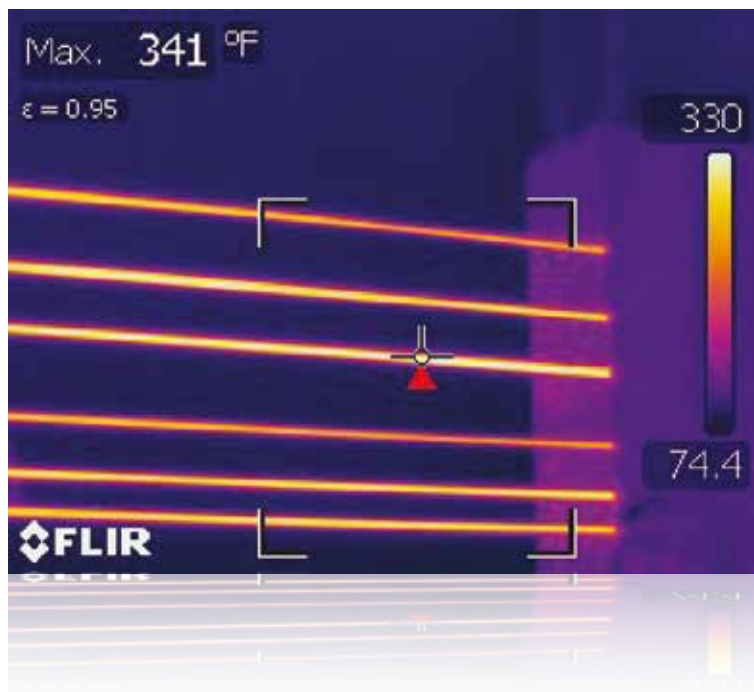

As in the case of many remote monitoring applications, the user may choose to route the camera's analog video to a control room monitor. For cameras with an Ethernet connection, digitally compressed (MPEG-4) streaming video can be available for monitoring on a PC screen. With FLIR's A320 camera, images and alarms can be sent to a remote PC via TCP/IP and SMTP (email) protocols.

While a visible light camera may be able to detect broken fiber strands, an IR camera can also provide temperature measurements for trending and statistical process control (SPC) purposes. In addition, some textile processes create steam or condensation vapors that a visible light camera cannot see through, but an IR camera can. Thus, an IR camera provides multiple functions and is more cost effective.

Data communications and software considerations

Different cameras have different video frame rates. The frame rate governs how frequently the thermographic image and its temperature data are updated. A typical rate might be every 200 ms or so. The camera's digital communications protocol could create a small amount of additional latency in the update process. Still, because process temperatures tend to change slowly, collecting temperature data at this rate provides a wealth of information for quality control purposes.

In many IR cameras there is some sort of serial/socket interface that can be used for communications with the PC or PLC that is running a control script, or application. When a system designer or user is most familiar with PLCs, the control algorithm can be built around a virtual PLC created on a PC, which emulates actual PLC hardware and logic. In any case, a human-machine interface (HMI) is created to monitor data coming from the camera. The details described below are based on FLIR's A320 camera, but should be representative of most cameras that transmit data over an Ethernet link.

The only physical interface for digital data transfer from the FLIR A320 is the Ethernet port. The camera should work seamlessly on any LAN when the proper IP address, netmask, and possibly a gateway is set up in the camera. The two main ways of controlling the camera are through the command control interface and the resource control interface. Digital image streaming, data file transfer, and other functionality is provided through the IP services interface. A lot of software functionality is exposed through software resources. These resources can be reached through the FLIR IP Resource Socket Service. This is the camera's resource control (serial/socket) interface. Independent of the physical Ethernet interface, it is possible to access the camera system using TCP/IP with telnet, ftp, http, and FLIR Resource Socket Services (among others).

Most PLCs provide serial/socket interfaces for Ethernet. One example is Allen-Bradley's EtherNet/IP Web Server Module (EWEB for short). Another example is HMS Industrial Network's Anybus X-Gateway Ethernet interface module, which can convert this serial socket interface to many industrial network protocols, such as EtherNet I/P, Modbus-TCP, Profinet, Ethernet Powerlink, EtherCAT, FLNet., etc.

Camera setup and data acquisition is normally done directly through the FLIR IR Monitor and IP CONFIG software running on a PC. Afterward, the camera can be connected on the network

for continuous monitoring and data logging via PC or PLC control. Typically, the telnet protocol, accessed by the Windows® PC running the application program, is used to query the camera for data. This protocol is also available for most PLCs.

The system designer or FLIR would create the message instructions that allow the PLC to query the camera for temperature data and thermographic images in the same way it is done with PC control. Alternatively, the PLC can hold the Ethernet port open and call for the camera to continuously output data to this port at the maximum rate possible. In either case, alarm functions and decision-making is performed by the application program running on the PLC (or PC if applicable). (See Figure 6.) Typically, temperatures and images collected for trend analysis and statistical process control purposes are stored on a separate server connected to the network, which is running transaction manager software for downloading and storing data.

For system developers who are writing or modifying code with Visual Basic, C++, etc. for customized applications running on a PC, there are a few options. FLIR's Researcher package supports OLE-2, the Microsoft standard for linking and embedding data between applications. Image and temperature data can be linked from Researcher into other compliant applications, such as Excel. The linked data updates automatically, so if a temperature value changes in Researcher it will automatically change in the linked application. In addition, Researcher provides an automation interface that can be used to control the software using Visual Basic or VBA. Other off-the-shelf options for OLE control include National Instruments' LabVIEW or MATLAB. However, none of the aforementioned are OPC (OLE for Process Control) compatible.

There are other out-of-the-box solutions that do not require the writing of application source code. One of these is IRControl from Automation Technology, GmbH. IRControl simplifies automated processing of complex tasks with its built in Automation Interface based on Microsoft® COM/DCOM. All essential measurement, analysis, and control functions for FLIR IR cameras are directly programmable using macro commands. This allows the execution of control scripts automatically based on digital input events. In addition, IRControl accepts remote control commands sent over an RS-232 link. Therefore, remote control of IRControl by other computers or PLCs is greatly simplified. The software also includes a comprehensive report generator.

Figure 6. Generalized IR machine vision system and its communications network

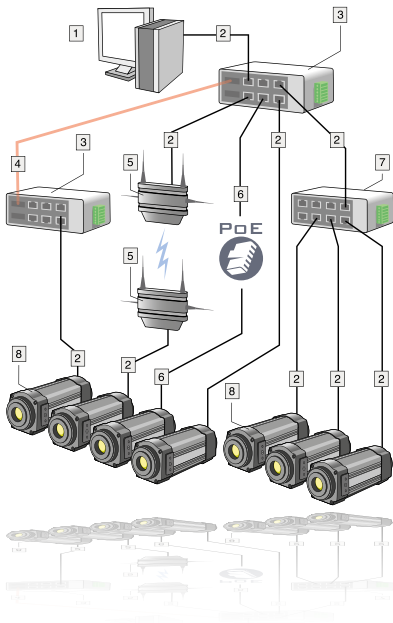

- 1 Computer, PLC, and/or transaction manager server
- 2 CAT-6 Ethernet cable with RJ45 connectors
- 3 Industrial Ethernet switches with fiber optic ports
- 4 Fiber optic cable
- 5 Wireless access points
- 6 CAT-6 Ethernet cable with RJ45 connectors, Powering the camera using PoE (Power over Ethernet)
- 7 Industrial Ethernet switch
- 8 FLIR A320 cameras monitoring a process or other target objects

SUMMARY

A variety of control and data acquisition options are available for IR cameras. They are similar to those used with visible light cameras that are employed in machine vision and automation systems. IR cameras provide the added advantage of accurate non-contact temperature measurements within a single instrument.



4

4. Combining machine vision and temperature measurement

Background

Traditionally, visible light cameras have been a mainstay in machine vision systems used for automated inspection and process control. Many of these systems also require temperature measurements to assure product quality. In numerous cases, an IR camera can supply both an image of the product and critical temperature data. If the application will not benefit from thermographic images and non-contact temperature measurements, then a visible light camera is certainly less expensive. If the opposite is true, then an IR camera should be considered by the system designer.

As the sophistication of IR cameras continues to increase, along with associated hardware and software, their use in automated systems is growing rapidly. Because of their combined imaging and temperature measurement capabilities, they can be very cost effective. The main impediment to their wider usage is system designers' lack of familiarity with IR camera features and the related standards, systems, and software that support them. This chapter supplies a good deal of that information.

Machine Vision Applications

As in the case of visible light cameras, thermographic cameras and their associated software can recognize the size, shape, and relative location of target objects (i.e., they can do pattern matching). Moreover, the electronics in newer IR cameras provide fast signal processing that allows high video frames rates (60 Hz or higher) to capture relatively fast-moving parts on a production line. Their A/D converters combine short integration times with high resolution, which is critical for properly characterizing moving targets or targets whose temperatures change rapidly.

Figure 1. Results of automated inspection of ICs on a circuit board

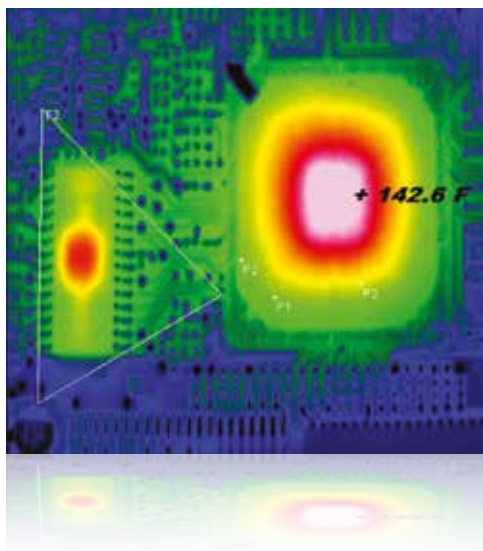

One example of the latter is automated inspection of operating ICs on a circuit board (Figure 1).

In some cases, this involves overload testing in which an IC is subjected to a current pulse so its heat loading can be characterized. In one such case the IC is forward and reverse biased with current levels outside of design limits using a pulse that lasts 800 ms. The IR camera captures images during and after the current pulse to characterize temperature rise and fall. With a 60 Hz frame rate, a new frame can be captured about every 17 ms. In such a system nearly 50 frames can be captured during the 800 ms pulse, and many more are typically captured afterward to reveal heat dissipation characteristics.

In other applications of this sort, a good image can be stored and compared to the inspection image by using pixel-by-pixel subtraction. Ideally, the resulting image would be entirely black, indicating no difference and a good part. Areas with excessive temperature differences indicate a bad part, making it very easy to discern unwanted differences.

There are many other applications where the combination of non-contact temperature measurements and imaging at high frame rates is extremely valuable. Some automated systems where IR cameras are already being used include:

- Automotive part production and assembly lines
- Steel mill operations, such as slag monitoring and ladle inspection
- Casting, soldering, and welding of metals and plastics
- Food processing lines
- Product packaging
- Non-destructive testing, like sub-surface detection of voids in molded parts
- Electric utility equipment monitoring
- R&D, prototyping, and production in the electronics industry

An interesting automotive example is monitoring the temperature distribution of a pressure casting mold for a safety-critical part (Figure 2). Prior to installation of the IR machine vision system, the manufacturer was doing 100% inspection using an X-ray system to reveal subsurface imperfections. It was not practical to do this as an inline procedure, so the X-rays were taken a few hours after part

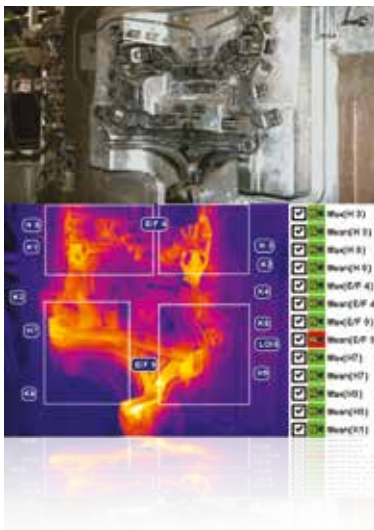

Figure 2. Pressure casting mold and its temperature distribution – an IR camera image is used by the operator to adjust the mold temperatures as required to produce good parts.

production. If the X-rays showed a significant problem in parts coming from a particular mold, this information was relayed to the production area so that mold temperatures could be adjusted. This was a lengthy and costly process that often resulted in high scrap rates. With the IR camera system, the mold operator can immediately check and adjust the temperature distribution of the mold.

Enabling Technology

Data communications are the backbone of modern industrial SCADA, PLC, HMI's, and Machine Vision systems. Ethernet has become the de facto standard for such systems. Considering this, the features of IR cameras that make for practical use in machine vision applications are Gigabit Ethernet (GigE) connectivity, GigE Vision™ compliance, a GenICam™ interface, and a wide range of third party software that supports these cameras. There are other hardware features that are also important.

Generally, ultra-high detector resolutions are not needed in the targeted applications, so a typical focal plane array (FPA) would be 320 x 240 pixels. Nevertheless, outputting a 16-bit image stream of these 76,800 pixels at a 60 Hz frame rate amounts to about 74 Mb/sec. While this is much slower than a 1000 baseT Ethernet system is capable of, multiple cameras may be connected and there may be a lot of other traffic on the network between image transmissions.

To speed up image transfers, data analysis and decision-making must take place outside the camera and is one of the reasons why there is a good market for third-party thermographic software. The other reason is that most machine vision systems are custom designed for specific production processes. Of course, IR camera manufacturers supply various types of software to support their products and facilitate application in these systems.

The goal of the GigE Vision technical standard is to provide a version of GigE that meets the requirements of the machine vision industry.

One of the industry objectives is the ability to mix and match components from various manufacturers that meet the standard. Another is relatively inexpensive accessories, such as cabling, switches, and network interface cards (NICs) as well as the ability to use relatively long cable runs where required.

The GigE Vision standard, which is based on UDP/IP, has four main elements:

- A mechanism that allows the application to detect and enumerate devices and defines how the devices obtain a valid IP address.
- GigE Vision Control Protocol (GVCP) that allows the configuration of detected devices and guarantees transmission reliability.
- GigE Vision Streaming Protocol (GVSP) that allows applications to receive information from devices.
- Bootstrap registers that describe the device itself (current IP address, serial number, manufacturer, etc.).

With GigE capabilities and appropriate software, an IR machine vision system does not require a separate frame grabber, which was typically the case with visible light cameras in the past. In effect, the GigE port on the PC is the frame grabber. Older visible light cameras that have only analog video outputs (NTSC and PAL) are limited to much lower frame rates and video monitor observations. By using GigE, an IR vision system not only has higher frame rates, but can be monitored remotely over much greater distances compared to local processing and transmitting data over USB, Firewire, CameraLink, etc. In addition, Ethernet components are inexpensive compared to frame-grabber cards and related hardware.

A GigE Vision camera typically uses an NIC, and multiple cameras can be connected on the network. However, the drivers supplied by NIC manufacturers use the Windows or Linux IP stack, which may lead to unpredictable behavior, such as data transmission delays. By using more efficient dedicated drivers compatible with the GigE Vision standard, the IP stack can be bypassed and data streamed directly to memory at the kernel level of the PC system. In other words, Direct Memory Access (DMA) transfers are negotiated, which also eliminates most CPU intervention. Thus a near-real-time IR vision system is created in which almost all of the CPU time is dedicated to processing images.

Figure 3. Official trademark for GigE compliant products



To make sure a camera is GigE Vision compliant, look for the official stamp (shown in Figure 3) that can only be applied if the camera conforms to the standard.

GenlCam compliance should also be considered for an IR camera. GenlCam compliance makes it easier for developers to integrate cameras into their IR vision system. The goal of the GenlCam standard is to provide a generic programming interface for all kinds of cameras. No matter what interface technology (GigE Vision, Camera Link, 1394, etc.) is used, or what camera features are being implemented, the application programming interface (API) should be the same. The GenlCam standard consists of multiple modules and the main tasks each performs are:

- GenApi: configuring the camera
- Standard Feature Names: recommended names and types for common features
- GenTL: transport layer interface, grabbing images

Common tasks associated with IR cameras in machine vision systems include configuration settings, command and control, processing the image, and appending temperature measurement results to the image data stream. GigE Vision makes hardware independence possible, while GenICam creates software independence. For example, in a system with IR cameras compliant in both and connected to a GigE network, virtually any application program can command a camera to send a 60 Hz stream of images that can be easily captured without dropping frames and losing important data. This information can be processed for alarm functions, trend analysis and statistical process control.

Third Party Software Expands Applications

By adhering to the standards described above, IR camera manufacturers are making it easier for developers to integrate their cameras into vision systems with a broad array of functions. Camera manufacturers also supply a variety of software products to ease integration tasks. For example, the FLIR A325 comes with three packages that run on a PC controller:

- IP Configuration utility – finds cameras on the network and configures them
- IR Monitor – displays images and temperature data on up to nine cameras simultaneously
- AXXX Control and Image interface – low-level descriptions of how to communicate with the camera, including image formats and C-code examples

In addition, optional software developer toolkits are available (FLIR SDK, LabVIEW Toolkit, Active GigE SDK from A&B Software, etc.) for those creating source code for custom applications within programming environments such as Visual Basic, C++, Delphi, etc. However, the strength of a camera like the A325 is its ability

Figure 4. Examples of the many functions available in Vision Builder for automated inspection

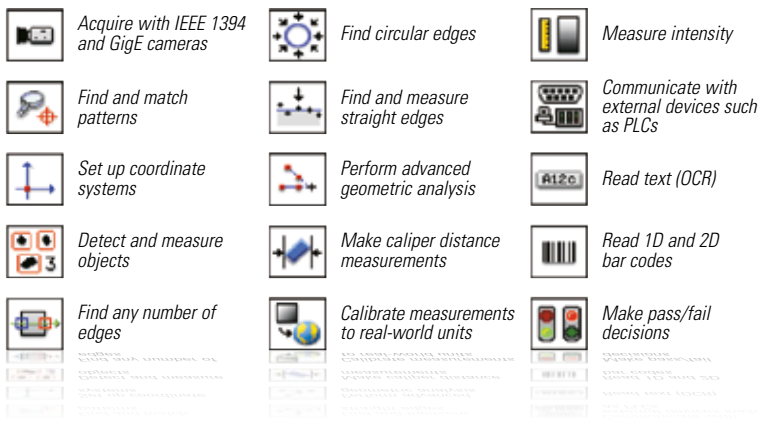

to interface with third party software that eliminates or minimizes the need to write source code. For example, National Instrument's Vision Builder for Automated Inspection is a configurable package for building, benchmarking, and deploying machine vision applications (Figure 5). It does not require the user to write program code. A built-in deployment interface facilitates system installation and includes the ability to define complex pass/fail decisions, control digital I/O, and communicate with serial or Ethernet devices, such as PLCs, PCs, and HMIs. Similar features are available in Common Vision Blox, a Stemmer Imaging product that contains hardware- and language-independent tools and libraries for imaging professionals.

By using third party software to get much of the analytics, command, and control functions out of the camera and onto a PC, application possibilities are greatly expanded. One possibility is creating a mixed camera system. For instance, IR cameras could be used to supply thermal images and temperature data, while visible light cameras could provide "white light" color recognition.

The food processing industry is one in which higher level analytics are used with IR cameras for automated machine vision applications. A broad area of applications where IR vision systems excel is in 100% inspection of cooked food items coming out of a continuous conveyor oven. A primary concern is making sure the items have been thoroughly cooked, which can be determined by having the camera measure their temperature, which is illustrated in Figure 5 for hamburger patties. This can be done by defining measurement spots or areas corresponding to the locations of burgers as they exit the oven. If the temperature of a burger is too low, the machine vision program logic not only provides an alarm, but also displays an image to the oven operator to show the specific burger that should be removed from the line. As in other applications, minimum, maximum, and average temperatures can be collected for specific burgers or the FOV as a whole and used for trending and SPC purposes.

In another example involving chicken tenders, temperature is again used to check for proper cooking. The pieces come out of the oven and drop onto another conveyor in more or less random locations (Figure 6). The operator can use the thermographic image to locate undercooked items within the randomly spaced parts and then remove them from the conveyor.

In the production of frozen entrées, IR machine vision can use pattern recognition software to check for proper filling of food tray

compartments. Similarly, it can be used for 100% inspection of the heat-sealed cellophane cover over the finished entrée. An added function could be laser marking of a bad item so it can be removed at the inspection station.

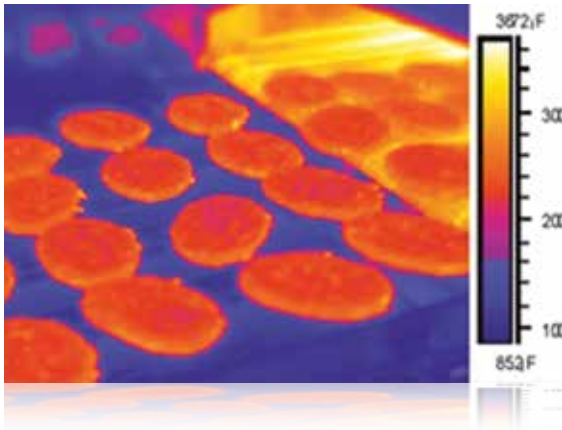

Figure 5. IR machine vision image for checking hamburger doneness by measuring temperature



Figure 6. An IR temperature measurement and thermographic image are used to locate undercooked chicken tenders and stop the line so bad parts can be removed.

SUMMARY

IR machine vision and temperature measurements can be applied to an infinite number of automated processes. In many cases, they provide images and information that are not available with visible light cameras, and they also complement white light images where the latter are required. IR cameras like the FLIR A325 provide a stream of digitized IR images at fast frame rates for relatively high-speed processes, which can be transmitted over GigE networks to remote locations. Compliance with GigE Vision and GenICam standards means that such cameras can be integrated with a wide variety of similarly compliant equipment and supported by a broad range of third party software. The availability of wireless and fiberoptic line adapters allow these cameras to be used almost anywhere, including over long distances.



To speak to a thermal imaging camera expert, please contact:

FLIR Commercial Systems B.V.

Luxemburgstraat 2
2321 Meer
Belgium
Tel.: +32 (0) 3665 5100
Fax: +32 (0) 3303 5624
e-mail: flir@flir.com

FLIR Systems Sweden

Antennvägen 6,
PO Box 7376
SE-187 66 Täby
Sweden
Tel.: +46 (0)8 753 25 00
Fax: +46 (0)8 753 23 64
e-mail: flir@flir.com

FLIR Systems UK

2 Kings Hill Avenue - Kings Hill
West Malling
Kent
ME19 4AQ
United Kingdom
Tel.: +44 (0)1732 220 011
Fax: +44 (0)1732 843 707
e-mail: flir@flir.com

FLIR Systems Germany

Berner Strasse 81
D-60437 Frankfurt am Main
Germany
Tel.: +49 (0)69 95 00 900
Fax: +49 (0)69 95 00 9040
e-mail: flir@flir.com

FLIR Systems France

20, bd de Beaubourg
77183 Croissy-Beaubourg
France
Tel.: +33 (0)1 60 37 01 00 (55 02 PM/
BLD/Law enforcement)
Fax: +33 (0)1 64 11 37 55
e-mail: flir@flir.com

FLIR Systems Italy

Via Luciano Manara, 2
I-20812 Limbiate (MB)
Italy
Tel.: +39 (0)2 99 45 10 01
Fax: +39 (0)2 99 69 24 08
e-mail: flir@flir.com

FLIR Systems Spain

Avenida de Bruselas, 15- 3º
28108 Alcobendas (Madrid)
Spain
Tel.: +34 91 573 48 27
Fax: +34 91 662 97 48
e-mail: flir@flir.com

FLIR Systems, Middle East FZE

Dubai Airport Free Zone
P.O. Box 54262
Office B-22, Street WB-21
Dubai - United Arab Emirates
Tel.: +971 4 299 6898
Fax: +971 4 299 6895
e-mail: flir@flir.com

FLIR Systems Russia

6 bld.1, 1st Kozjevnickesky lane
115114 Moscow
Russia
Tel.: + 7 495 669 70 72
Fax: + 7 495 669 70 72
e-mail: flir@flir.com

**Asia Pacific Headquarter
HONG KONG**

FLIR Systems Co. Ltd.
Room 1613 – 16, Tower 2,
Grand Central Plaza,
No. 138 Shatin Rural Committee
Road, Shatin, New Territories,
Hong Kong
Tel.: +852 2792 8955
Fax: +852 2792 8952
Email: flir@flir.com.hk

FLIR Systems (Shanghai) Co. Ltd.

Head Office
Tel: +86 21 5169 7628
Fax: +86 21 5466 0289
Email: info@flir.cn

Beijing Representative Office

Tel: +86 10 5979 7755
Fax: +86 10 5907 3180
Email: info@flir.cn

Guangzhou Representative Office

Tel: +86 20 8600 0559
Fax: +86 20 8550 0405
Email: info@flir.cn

FLIR Systems Japan K.K.

Tel: +81 3 6277 5681
Fax: +81 3 6277 5682
Email: info@flir.jp

FLIR Systems Korea Co., Ltd

Tel: +82 2 565 2714
Fax: +82 2 565 2718
Email: flir@flirkorea.com

**FLIR Systems Taiwan
Representative Office**

Tel: +886 2 2757 9662
Fax: +886 2 2757 6723
Email: flir@flir.com.hk

FLIR Systems India PVT. Ltd.

Tel: +91 11 4560 3555
Fax: +91 11 4721 2006
Email: flirindia@flir.com.hk

FLIR Systems Australia

10 Business Park Drive,
Notting Hill, Vic 3168
Toll Free: 1300 729 987
New Zealand: 0800 785 492
Tel: +61 (0)3 9550 2800
Email: info@flir.com.au

You are always welcome to visit us at:
www.flir.com/thg