

Part number:

62101-0301

Copyright

© 2013, FLIR Systems, Inc.

All rights reserved worldwide. Names and marks appearing herein are either registered trademarks or trademarks of FLIR Systems and/or its subsidiaries. All other trademarks, trade names or company names referenced herein are used for identification only and are the property of their respective owners.

March 06, 2013, 04:49 AM

Corporate Headquarters

FLIR Systems, Inc.
27700 SW Parkway Ave.
Wilsonville, OR 97070
USA
Telephone: +1-503-498-3547

Website

<http://www.flir.com>

Customer support

<http://support.flir.com>

Legal disclaimer

Specifications subject to change without further notice. Camera models and accessories subject to regional market considerations. License procedures may apply.

Information and equipment described herein may require US Government authorization for export purposes. Diversion contrary to US law is prohibited.



Imaging and optical data

IR resolution	320 × 240 pixels
Thermal sensitivity/NETD	< 45 mK @ +30°C (+86°F)
Field of view (FOV) / Minimum focus distance	25° × 19° / 0.4 m (1.31 ft.)
Spatial resolution (IFOV)	1.39 mrad
Image frequency	60 Hz
Focus	Automatic (one shot) or manual
Zoom	2x, 4x and 8x digital zoom
Focal Plane Array (FPA) / Spectral range	Uncooled microbolometer / 7.5–13 μm

Image presentation

Display	Touch screen, 3.5 in. LCD, 320 × 240 pixels
Image modes	IR image, visual image, thermal fusion, picture in picture, thumbnail gallery
Thermal fusion	IR image shown above, below or within temp interval on visual image
Multi Spectral Dynamic Imaging (MSX)	IR-image with enhanced detail presentation
Picture in Picture	Resizable and movable IR area on visual image

Measurement

Object temperature range	-20°C to +120°C (-4°F to +248°F) 0°C to +650°C (+32°F to +1202°F) +250°C to +1200°C (+482°F to +2192°F)
Accuracy	±2°C (±3.6°F) or ±2% of reading, for ambient temperature 10°C to 35°C (+50°F to 95°F)

Measurement analysis

Spotmeter	5
Area	5 boxes with max./min./average
Automatic hot/cold detection	Auto hot or cold spotmeter markers within area
Isotherm	Detect high/low temperature/interval
Profile	1 live line
Measurement presets	Yes
Difference temperature	Delta temperature between measurement functions or reference temperature
Emissivity correction	Variable from 0.01 to 1.0 or selected from materials list
External optics/windows correction	Automatic, based on inputs of optics/window transmission and temperature
Measurement corrections	Reflected temperature, optics transmission and atmospheric transmission
Measurement function alarm	Audible/visual alarms (above/below) on any selected measurement function

P/N: 62101-0301

© 2013, FLIR Systems, Inc.
All rights reserved worldwide.

Set-up	
Color palettes	Arctic, Gray, Iron, Lava, Rainbow and Rainbow HC
Set-up commands	User programmable button, local adaptation of units, language, date and time formats
Storage of images	
Image storage	Standard JPEG, including measurement data, on memory card
Image storage mode	IR/visual images; simultaneous storage of IR and visual images
Periodic image storage	7 seconds to 24 hours (IR) 14 seconds to 24 hours (IR and visual)
Image annotations	
Voice	60 seconds (via Bluetooth)
Text	Text from predefined list or soft keyboard on touch screen
Sketch	From touch screen
Image sketch	On IR and visual image
External sensors	Possible to connect (Bluetooth®): Extech Moisture Meter MO297 Extech Clamp Meter EX845
Report generation	<ul style="list-style-type: none"> Instant Report (*.pdf file) in camera including IR and visual images Separate PC software with extensive report generation
Video recording in camera and video streaming	
Non-radiometric IR-video recording	MPEG-4 to memory card
Visual video recording	MPEG-4 to memory card
Radiometric IR-video streaming	Full dynamic to PC using USB or Wi-Fi
Non-radiometric IR-video streaming	MPEG-4 using Wi-Fi Uncompressed colorized video using USB
Digital camera	
Built-in digital camera	3.1 Mpixel (2048 × 1536 pixels), and one LED light
Digital camera, FOV	Adapts to the IR lens
Built-in digital lens data	FOV 53° × 41°
Laser pointer	
Laser	Activated by dedicated button
Laser alignment	Position is automatic displayed on the IR image
Data communication interfaces	
Interfaces	USB-mini, USB-A, Bluetooth, Wi-Fi, composite video
Bluetooth	Communication with headset and external sensors
Wi-Fi	Peer to peer (ad hoc) or infrastructure (network)
USB	<ul style="list-style-type: none"> USB-A: Connect external USB device USB Mini-B: Data transfer to and from PC / Uncompressed colorized video
Radio	
Wi-Fi	Standard: 802.11 b/g Frequency range: 2412–2462 MHz Max output power: 15 dBm
Bluetooth	Frequency range: 2402–2480 MHz
Antenna	Internal
Power system	
Battery	Li Ion, 4 hours operating time
Charging system	In camera (AC adapter or 12 V from a vehicle) or 2-bay charger



FLIR T440 25° (incl. Wi-Fi)

P/N: 62101-0301

© 2013, FLIR Systems, Inc.
All rights reserved worldwide.

Power system

Power management	Automatic shutdown and sleep mode (user selectable)
------------------	---

Environmental data

Operating temperature range	-15°C to +50°C (+5°F to +122°F)
Storage temperature range	-40°C to +70°C (-40°F to +158°F)
Humidity (operating and storage)	IEC 60068-2-30/24 h 95% relative humidity +25°C to +40°C (+77°F to +104°F) / 2 cycles
EMC	<ul style="list-style-type: none">• ETSI EN 301 489-1 (radio)• ETSI EN 301 489-17• EN 61000-6-2 (Immunity)• EN 61000-6-3 (Emission)• FCC 47 CFR Part 15 B (Emission)• ICES-003
Radio spectrum	<ul style="list-style-type: none">• ETSI EN 300 328• FCC Part 15.247• RSS-210
Encapsulation	IP 54 (IEC 60529)
Bump	25 g (IEC 60068-2-29)
Vibration	2 g (IEC 60068-2-6)
Safety	EN/UL/CSA/PSE 60950-1

Physical data

Camera weight, incl. battery	0.880 kg (1.94 lb.)
Camera size (L x W x H)	106 x 201 x 125 mm (4.2 x 7.9 x 4.9 in.), with built-in lens pointing forward
Tripod mounting	UNC ¼"-20 (adapter needed)

Shipping information

- Infrared camera with lens
- Battery (2 ea.)
- Battery charger
- Bluetooth headset
- Calibration certificate
- Camera lens cap
- Downloads brochure
- FLIR Tools download card
- FLIR Apps card
- Getting Started Guide
- Hard transport case
- Important Information Guide
- Memory card
- Neckstrap
- Optics brochure
- Power supply, incl. multi-plugs
- Service & training brochure
- Sunshield
- Thank you card
- USB cable
- User documentation CD-ROM
- Video cable
- Warranty extension card

Camera with built-in IR lens f=18 mm (25°)

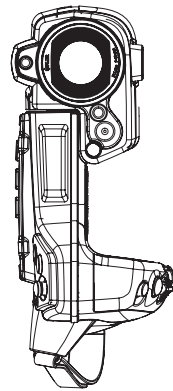
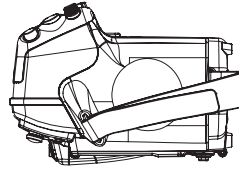
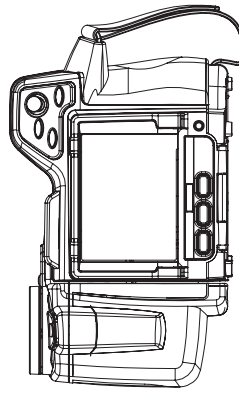
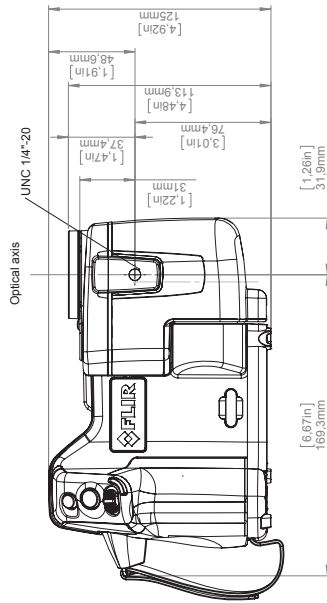
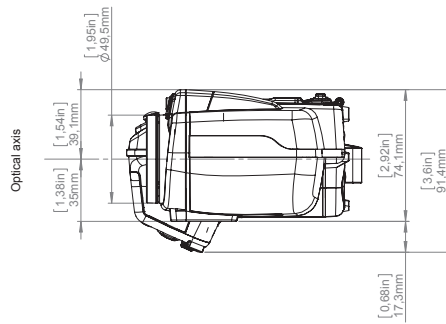
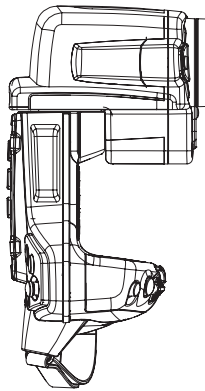
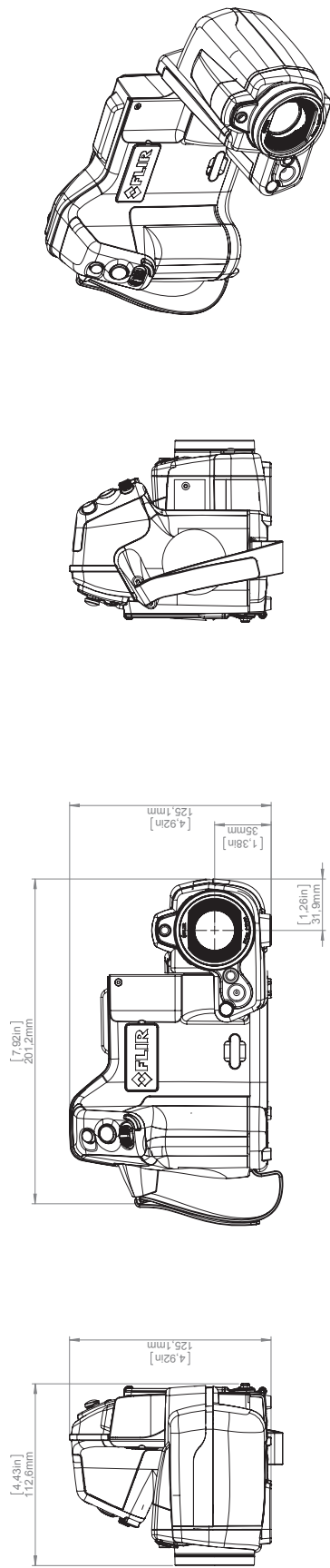

	Modified 2012-06-07 Denomination	Check JOTA	Drawn By R&D Thermography	Size A3	Sheet 1(7)
			Drawing No. T127604	Scale 1:2	Size A
Basic Dimensions FLIR T4xx					